

Operating manual

Electric motor

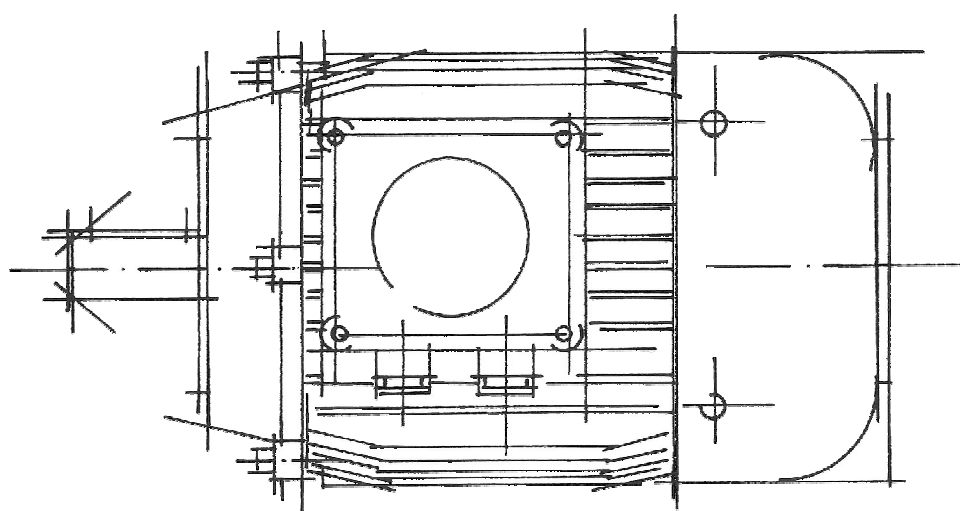

Elektromotoren
Läutemaschinen
Kirchturmuhren



© Herforder Elektromotoren-Werke
GmbH & Co. KG
Goebenstr. 106
D-32051 Herford

Tel.: +49 (0) 5221 5904-0
Fax: +49 (0) 5221 5904-34

E-Mail: info@hew-hf.de
Internet: www.hew-hf.de

Release:

Author:
Kothes!
Technische Kommunikation GmbH & Co. KG
www.kothes.de

This issue replaces all previous issues. All previous
issues are invalid. The date of issue (⇒ foot note) is
authoritative.

1	General information.....	5
1.1	Information on this operating manual.....	5
1.2	Explanation of symbols	6
1.3	Limitation of liability.....	7
1.4	Copyright	8
1.5	Spare parts.....	8
1.6	Warranty conditions	8
1.7	Customer service.....	8
2	Safety	9
2.1	Responsibility of the user	9
2.2	Staff requirements.....	10
2.2.1	Qualifications	10
2.2.2	Unauthorised parties	11
2.2.3	Training.....	11
2.3	Proper use	12
2.4	Personal safety equipment and clothing	13
2.5	Special hazards	13
2.6	Safety devices	16
2.7	Securing the machine to prevent it from being switched back on	16
2.8	How to act in case of hazards and accidents	17
2.9	Environmental protection.....	18
3	Technical data.....	19
3.1	Operating conditions	19
3.2	Type plate.....	19
4	Construction and function	20
4.1	Overview	20
4.2	Connections.....	21
4.3	Operation on the frequency converter	21
5	Transportation, packaging and storage.....	22
5.1	Delivery inspection.....	23
5.2	Transportation.....	23
5.3	Packaging.....	25
5.4	Bearings	26



Table of contents

6	Installation and commissioning	27
6.1	Safety	27
6.2	Installation	28
6.2.1	Ventilation at the location for use.....	28
6.2.2	Types of construction as per EN 60034-7	29
6.2.3	Erecting the machine	32
6.2.4	Installation	32
6.3	Connecting to the energy supply	33
6.3.1	Voltage, frequency and circuit	33
6.3.2	Checking the insulation resistance	34
6.4	Commissioning	34
7	Operations	36
7.1	General information	36
7.2	Shutting down in an emergency	36
8	Faults	37
8.1	Safety	37
8.2	Fault table.....	39
8.3	Commissioning after remedied fault	40
9	Maintenance	41
9.1	Safety	41
9.2	Cleaning	43
9.3	Maintenance schedule	43
9.4	Tightening torque values for screws.....	44
9.4.1	Tightening torque values for screws for electrical connections.....	44
9.4.2	Screw connections, property class 8.8 and A4-70.....	44
9.4.3	Screw connections of property class 5.6.....	45
9.5	Measures on completion of maintenance	45
10	Removal	46
10.1	Safety	46
10.2	Removal	47
10.3	Disposal	48
11	Index	49

1 General information

1.1 Information on this operating manual

This operating manual makes it possible to handle the machine safely and efficiently.

The manual is a component of the machine and must be kept in the direct vicinity of the plant and be accessible to staff at all times. Staff must have carefully read and understood this manual before starting all work. Adherence to all the specified safety instructions and instructions for actions in this operating manual is a fundamental requirement for working safely.

The local regulations for the prevention of accidents and the general safety regulations for the location in which the machine is used also apply.

The illustrations in this operating manual are for purposes of general understanding and may differ from the actual machine version.

General information

1.2 Explanation of symbols

Safety instructions

The safety instructions in this manual are indicated by symbols. The safety instructions are introduced by signal words which express the extent of the risk.

It is imperative to adhere to safety instructions and act with caution in order to prevent accidents, personal injury and material damage.



DANGER!

... indicates an immediately dangerous situation which will lead to death or serious injuries if not avoided.



WARNING!

... indicates a possibly dangerous situation which may lead to death or serious injuries if not avoided.



CAUTION!

... indicates a possibly dangerous situation which may lead to minor or light injuries if not avoided.



CAUTION!

... indicates a possibly dangerous situation which may lead to material damage if not avoided.

Tips and recommendations



NOTE!

... draws attention to tips and recommendation and information for efficient, fault-free operation.

Special safety instructions

The following symbols are used in safety instructions in order to point out particular hazards.



... indicates risks from electrical current. Failure to observe the safety instructions will result in the risk of serious or fatal injury.

1.3 Limitation of liability

All the information and instructions in this manual have been complied in line with the valid standards and regulations, state-of-the-art technology and our many years of experience and know-how.

The manufacturer shall not be liable for damages caused by:

- Failure to observe the manual
- Improper use
- Employment of unqualified staff
- Arbitrary modifications
- Technical changes
- Use of non-approved spare parts

In case of special versions, the utilisation of additional order options or due to new technical changes, the actual scope of delivery may differ from the explanations described here and the illustrations.

The obligations agreed in the delivery contract, the General terms and Conditions and the Terms and Conditions of Delivery of the manufacturer, and the legal regulations valid at the point of completion of the contract apply.

We reserve the right to make technical changes within the scope of further development and improvement of the performance characteristics.

General information

1.4 Copyright

This operating manual is protected by copyright and for internal use only.

The manual must not be made available to third parties, reproduced in any way (including excerpts), its content must not be utilised and/or communicated without the written approval of the manufacturer, except for internal purposes.

Failure to comply will render the offender liable for damages. We reserve the right to further claims.

1.5 Spare parts

**WARNING!**

The use of incorrect parts is a risk to safety.

Incorrect or faulty parts can compromise safety and cause damage, malfunctions or complete failure.

Therefore:

- Only use the manufacturer's original spare parts.

Purchase spare parts from authorised dealers or directly from the manufacturer. See page 2 for the address.

The spare parts list can be found on pages 20-21.

1.6 Warranty conditions

The warranty conditions are included in the manufacturer's General Terms and Conditions.

1.7 Customer service

Our customer service department is available to provide technical information. See page 2 for contact details.

Furthermore our staff are always interested in receiving new information and hearing of new experiences gained from the use of our products which can be used to improve our products.

2 Safety

This section provides you with an overview of all important aspects of safety required for providing staff with optimum protection as well as safe, fault-free operation.

Failure to observe the instructions and safety instructions for actions in this operating manual can cause considerable risks.

2.1 Responsibility of the user

The machine is used in the commercial field. The user of the machine is therefore subject to the legal obligations for occupational safety.

In addition to the safety instructions in this manual, the regulations for safety, accident prevention and environmental protection which apply at the location for use of the machine must also be observed. The following in particular applies:

- The user must fully acquaint himself with the valid occupational safety regulations and, in addition, carry out a risk assessment to determine the hazards which result from the particular working conditions at the location in which the machine is used. The results must be implemented as a set of operating instructions for operation of the machine.
- The user must carry out checks during the entire period of its use to determine whether the operating instructions drawn up are in line with the current regulations and adjust them as necessary.
- The user must clearly set out the responsibilities for installation, operation, maintenance and cleaning.
- The user must make sure that all staff involved with work on the machine have read and understood the manual. Furthermore, staff must be provided with training and information on the hazards at regular intervals.
- The user must provide staff with the required safety clothing and equipment.

The user is also responsible for ensuring that the machine is kept in technically perfect condition. The following applies:

- The user must make sure that the maintenance intervals described in the operating manual are adhered to.
- The user must have all the safety devices checked regularly to make sure they are complete and fully functional.

2.2 Staff requirements

2.2.1 Qualifications

**WARNING!**

Risk of injuries in case of insufficiently qualified staff.

Improper use can cause considerable personal injury and material damage.

Therefore:

- Have all tasks performed by staff with the appropriate qualifications only.

The following levels of qualification are named in the operating manual for various ranges of tasks.

■ **Trained person**

has been informed of the tasks with which he has been entrusted and the possible risks in case of incorrect behaviour in training measures provided by the user.

■ **Specialist staff**

are capable of carrying out the work with which they have been entrusted and recognising the potential risks independently because of their specialist qualifications, knowledge and experience, and knowledge of the valid regulations.

■ **Qualified electrician**

is capable of carrying out the work on electrical equipment and recognising and preventing the potential risks independently because of their specialist qualifications, knowledge and experience, and knowledge of the valid standards and regulations.

The qualified electrician is qualified to work in the specific area in which he works and is familiar with the relevant standards and regulations.

Staff should be made up exclusively of people who can be expected to carry out their work reliably. People whose reactions are influenced, for instance, by drugs, alcohol or medication, must not be allowed.

- When selecting staff adhere to the valid local regulations relating to age and profession.

2.2.2 Unauthorised parties



WARNING!

Danger for unauthorised parties.

Unauthorised persons who do not meet with the requirements described here, are not familiar with the hazards in the working area.

Therefore:

- Keep unauthorised persons away from the working area.
- In case of doubt, approach these persons and instruct them to leave the working area.
- Stop work until any unauthorised parties have left the working area.

2.2.3 Training

Staff must be provided with regular training by the user. Training must be logged to keep better track.

Date	Name	Type of training	Training provided by	Signature

Fig. 1

2.3 Proper use

The machine has been engineered and designed exclusively for the proper use described in this documentation.

The machine is use exclusively as a drive in commercial high voltage systems.

Proper use also includes adherence with all the stipulations of this manual.

Any other type of use, or use of the machine going beyond this use is considered improper use and can cause dangerous situations.

**WARNING!****Danger from improper use.**

Improper use of the machine can cause dangerous situations.

Take particular care not to use the machine as follows:

- Operation beyond the original designated application.
- Operation of machines in potentially explosive areas which do not have explosion protection markings and are thus not suitable for use in a potentially explosive atmosphere.

Claims of any kind for damages caused by improper use are null and void.

The user carries sole liability for any damages in case of improper use.

2.4 Personal safety equipment and clothing

Whilst work is being carried out, personal safety equipment and clothing must be worn in order to minimise health hazards.

- Always the safety clothing and equipment required for the respective task whilst working.
- Follow the instructions in the working area on personal safety equipment and clothing.

To be worn for all work



The following must be worn for all work:

Occupational safety clothing

is close-fitting working clothing with a low tear strength, close-fitting sleeves and no protruding parts. It serves primarily as protection from entanglement in moving machine parts.

Do not wear rings, chains or other jewellery.



Safety shoes

to protect from heavy falling parts and from slipping on slippery surfaces.

2.5 Special hazards

The following section points out residual risks which have been determined by a risk analysis.

- Adhere to the safety instructions listed here and the warnings in other chapters in order to reduce health hazards and prevent dangerous situations.

Safety

Electrical current



DANGER!

Danger to life from electrical current.

There is an immediate risk of fatal injury in case of contact with live parts. Damage to the insulation or individual components can mean danger to life.

Therefore:

- In case of damage to the insulation, switch off the power supply immediately and have repairs carried out.
- Have work on the electrical equipment carried out by qualified electricians only.
- When any work is carried out on the electrical equipment, disconnect it from the power and make sure it is free of voltage.
- Before carrying out maintenance, cleaning and repair work, switch off the power supply and secure it to prevent it from being switched back on.
- Do not jumper or disable any fuses or circuit breakers. When replacing fuses or circuit breakers make sure to adhere to the correct ampere rating.
- Keep moisture away from live parts. It can lead to a short circuit.

Moving parts



WARNING!

Risk of fatal injury from moving parts.

Rotating parts and/or parts which move linearly can cause serious injuries.

Therefore:

- Do not reach into moving parts or handle moving parts during operation.
- Do not open covers during operation.
- Adhere to the follow-up time:
Before opening covers make sure that none of the parts are still moving.
- In the danger area wear close-fitting protective clothing.

Hot surfaces**CAUTION!****Risk of burns from hot surfaces.**

Contact with hot parts can cause burns.

Therefore:

- When working in the vicinity of hot parts always wear protective clothing and protective gloves.
- Before carrying out any work make sure that all components have cooled to ambient temperature.

Soiling and objects lying around**CAUTION!****Risk of stumbling due to soiling and objects left lying around.**

Soiling and objects left lying around are sources of slipping and stumbling and can cause considerable injuries.

Therefore:

- Always keep the working area clean.
- Remove any objects which are no longer required.
- Mark any possible stumbling hazards with yellow and black marker tape.

Sharp edges and corners**CAUTION!****Risk of injuries from edges and corners.**

Sharp edges and corners can cause grazes and cuts on the skin.

Therefore:

- Proceed with caution when working in the vicinity of sharp edges and corners.
- If in doubt wear protective gloves.

2.6 Safety devices

Integration into an emergency stop concept required

The machine is for use within a plant. It does not have its own control unit and does not have an independent emergency stop function.

Before the machine is put into operation install the emergency stop devices for the machine and integrate it into the plant control unit's safety chain.

Connect the emergency stop devices so that there is no chance that dangerous situations for people and objects of material value cannot arise if the energy supply is broken or the energy supply is activated after being broken.

The emergency stop devices must be freely accessible at all times.

2.7 Securing the machine to prevent it from being switched back on



DANGER!

Risk of fatal injury if the machine is switched back on without authorisation.

When working in the danger area there is a risk that the energy supply will be switched on without authorisation. This puts the life of people in the danger area at risk.

Therefore:

- Adhere to the instructions on securing the machine to prevent it from being switched on in the chapters of this manual.
- Always adhere to the procedure described below to secure the machine to prevent it from being switched back on.

Switch secured with a padlock
 on: at h.
DO NOT SWITCH ON
 The padlock must only be removed
 by:
 once you have made sure that there is
 nobody in the danger area.

Fig. 2

Switched off
 on: at h.
DO NOT SWITCH ON
 Only to be switched on
 by:
 once you have made sure that there is
 nobody in the danger area.

Fig. 3

Securing the machine to prevent it from being switched back on:

1. Switch off the energy supply.
2. If possible, secure the switch with a padlock and attach a clearly visible sign to the switch Fig. 2.
3. Have the key kept safely by the member of staff named on the sign.
4. If it is possible to secure a switch with a padlock, erect a sign accordingly Fig. 3.
5. Once all work has been carried out, make sure that nobody is in the danger area.
6. Make sure that all safety devices and mechanisms are installed and fully functional.
7. Do not remove the sign until you have done so.

2.8 How to act in case of hazards and accidents

Preventive measures

- Always be prepared for accidents or fires.
- Keep first aid facilities (first aid box, blankets etc.) and fire extinguishers accessible at all times.
- Familiarise staff with accident report, first aid and rescue facilities.
- Keep access routes for emergency vehicles clear.

Measures in case of accidents

- Trigger an emergency stop immediately.
- Instigate first aid measures.
- Remove any people from the danger zone.
- Inform the responsible party at the location.
- Notify emergency services.
- Clear access routes for emergency vehicles.

2.9 Environmental protection

**CAUTION!****Risk of environmental damage in case of incorrect handling.**

Incorrect handling of environmentally hazardous substances, in particular incorrect disposal, can cause considerable damage to the environment.

Therefore:

- Always adhere to the instructions below.
- If environmentally hazardous substances are accidentally released into the environment, take suitable measures immediately. In case of doubt inform the responsible local authority of the damage.

The following environmentally hazardous substances are used:

Lubricants

**CAUTION!****Risk of environmental damage from lubricants.**

Coolants and lubricants, such as grease and oils, contains toxic substances which may damage the environment.

Therefore:

- Make sure that the substances do not enter into the environment.
- Have disposal performed by a specialist company.

**NOTE!**

The motors comply with EC Directive 2002/95/EC for the limitation of the use of certain hazardous substances in electrical and electronic devices.

3 Technical data

NOTE!

The necessary technical data can be found on the respective type plates. This information is authoritative.

Further technical data can be taken from the catalogue.

3.1 Operating conditions

Environment

Specification	Value	Unit
Temperature range	-20...+40	°C
Temperature range (optional)	-25...+60	°C
Relative air humidity, maximum	60	%
Maximum installation height above sea level	1000	m

3.2 Type plate

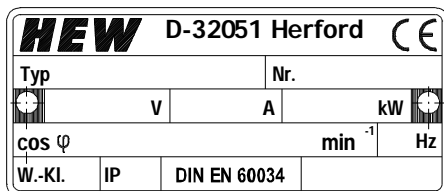

Fig. 4: Example of a type plate

The type plate is situated on the motor housing and the information it contains includes:

- Manufacturer
- CE symbol
- Motor identification
- Performance data

NOTE!

The information on the type plate may vary depending on the type of motor.

NOTE!

There may be further signs on the machine with various pieces of information.

Construction and function

4 Construction and function

4.1 Overview

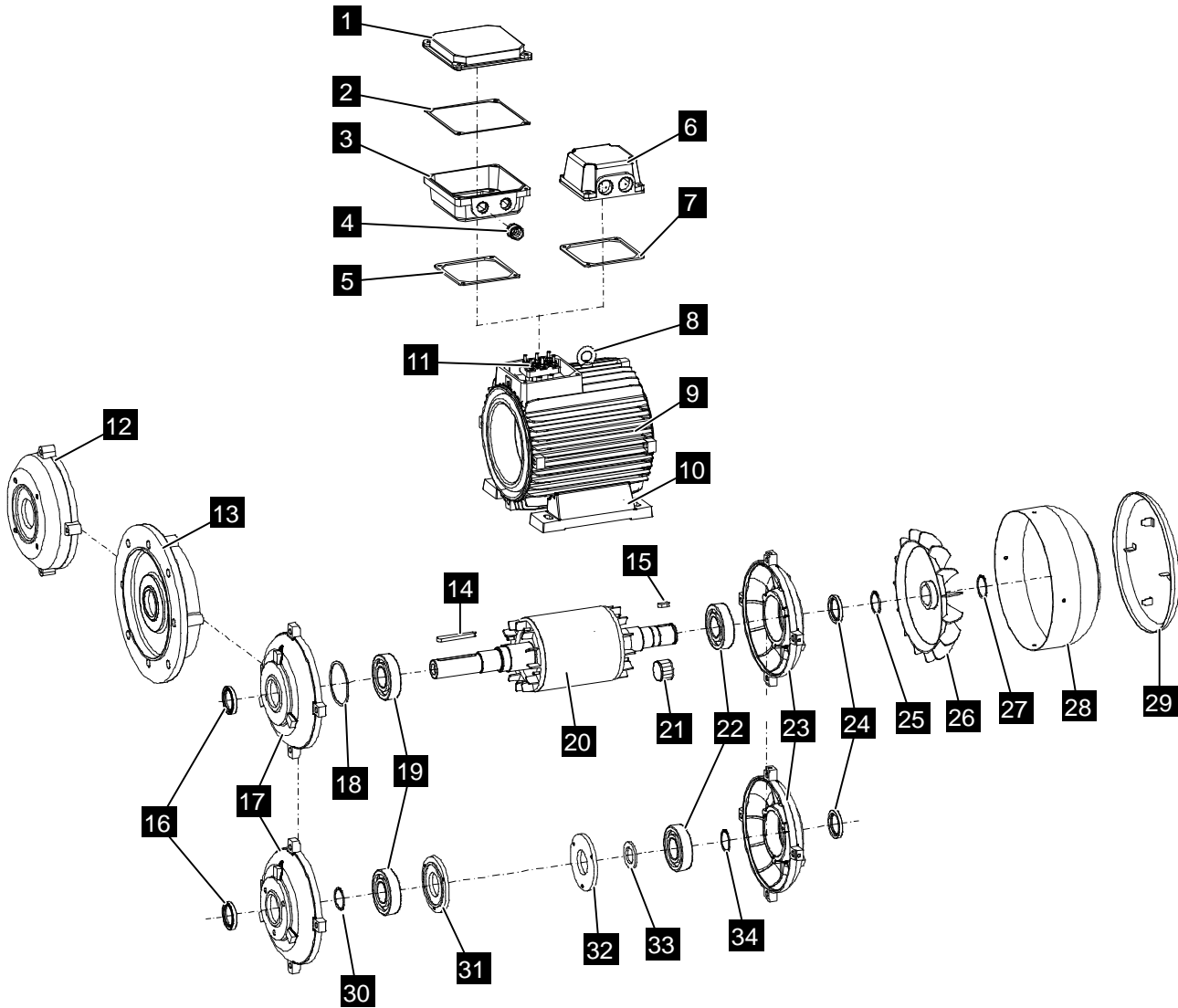

Fig. 5: Overview

- | | | | |
|----|---|----|-------------------------------------|
| 1 | Terminal box cover | 18 | Ball bearing adjusting washer |
| 2 | Terminal box cover seal | 19 | Rolling bearings (DS)* ¹ |
| 3 | Terminal box | 20 | Rotor shaft, complete |
| 4 | Screwed cable gland | 21 | Tolerance ring (fan blade) |
| 5 | Terminal box seal | 22 | Rolling bearing (NS)* ² |
| 6 | Terminal box (single-piece) | 23 | Bearing shield (NS)* ² |
| 7 | Terminal box seal | 24 | Sealing ring (NS)* ² |
| 8 | Ring bolt | 25 | Retaining ring (fan) |
| 9 | Stator housing assembly including feet (IM B3)/ without feet (IM B5/IM B14) | 26 | Fan |
| 10 | Motor feet | 27 | Retaining ring (fan) |
| 11 | Terminal board | 28 | Ventilation hood |
| 12 | Flange bearing shield IM B14 | 29 | Safety cover |
| 13 | Flange bearing shield IM B5 | 30 | Retaining ring (rolling bearing) |
| 14 | Feather key (shaft end) - optionally | 31 | Bearing cap (DS)* ¹ |
| 15 | Feather key (fan blade) - optionally | 32 | Bearing cap (NS)* ² |
| 16 | Sealing ring (DS)* ¹ | 33 | Supporting disk |
| 17 | Bearing shield (DS) * ¹ IM B3 | 34 | Retaining ring (rolling bearing) |

*¹ (DS) = drive side

*² (NS) = non-drive side

4.2 Connections

The electrical connections are established using the terminal box. The wiring diagram is inside the terminal box.

Optionally the motors can be supplied with a motor cable instead of with a terminal box (⇒ catalogue).

4.3 Operation on the frequency converter

As well as the cooling effect of the internal fan, the noise and vibration performance also changes frequently which is caused by the harmonic content of the converter output voltage. This causes the additional losses in the motor to increase. When operating above the nominal speed the maximum speed is limited by the mechanical strain of the internal fan and the critical speed of the ball bearing.

When operating with converter the motor protection provided by the motor protection switch is no longer sufficient. Only temperature monitoring using thermal sensors (posistors or thermostatic switches) in the coil provides reliable protection.

With a supply via converter high-frequency current and voltage harmonics in the motor cables can cause electromagnetic interference emissions. You must therefore use screened supply cables.

5 Transportation, packaging and storage

Suspended loads

**WARNING!****Risk of fatal injury from suspended loads.**

When lifting loads there is a risk of fatal injuries from falling parts or parts swinging uncontrolledly.

Therefore:

- Never stand under suspended loads.
- Only use the stipulated fastening points.
- Do not fasten lifting gear to protruding machine parts or the lugs on attached parts. Make sure the fastening equipment is securely fastened.
- Only use approved lifting gear and fastening equipment with sufficient load bearing capacity.
- Do not use any torn or frayed ropes or belts.
- Do not attach ropes and belts to sharp edges and corners. Do not knot or twist them.

Off-centre centre of gravity

**WARNING!****Risk of falling due to an off-centre centre of gravity.**

Packages may have an off-centre centre of gravity. If fastened incorrectly the package may tilt and cause potentially fatal injury.

Therefore:

- Adhere to the markings on the packages.
- Attach the crane hook so that it is directly above the centre of gravity.
- Lift cautiously and observe whether the load tilts. If necessary change the fastening.

Improper transportation

CAUTION!
Risk of damage in case of improper transportation.

Improper transportation can cause considerable material damage.

Therefore:

- When unloading delivered packages and when transporting on the premises, proceed with caution and adhere to the symbols and instructions on the packaging.
- Only use the fastening points provided.
- Do not remove the packaging until shortly before installation.

5.1 Delivery inspection

Inspect the delivery for damage and to make sure it is complete immediately after receiving it.

Proceed as follows in case of visual external damage:

- Refuse delivery or accept delivery provisionally.
- Make a note of the extent of damage in the shipping documents or on the carrier's delivery note.
- Make a claim.

NOTE!

Make a claim for every discrepancy as soon as it is discovered. Claims for compensation can only be asserted within the valid claims periods.

5.2 Transportation
Fastening points

- Use suitable lifting gear.
- Use the lifting eyebolts provided on the motor.
- To transport machine sets (e.g. gear units, fan attachments etc.) only use the lifting eyebolts and lugs provided. Machine sets must not be lifted by the individual machines.
- Remove any transport safety devices which protect from bearing damage before commissioning.

Transportation, packaging and storage

Transporting packages by crane

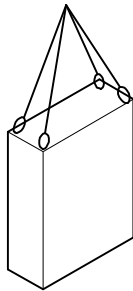

Fig. 6

Packages which have fastening eyebolts can be transported directly by crane on the following conditions:

- The crane and lifting gear must be designed for the weight of the packages.
- The operator must be authorised to operate the crane.

Fastening:

1. Fasten ropes, belts or multiple-point suspension gear Fig. 6 accordingly.
2. Make sure that the package hangs straight, paying attention to the off-centre centre of gravity as necessary.
3. Begin transportation.

Transporting pallets by crane

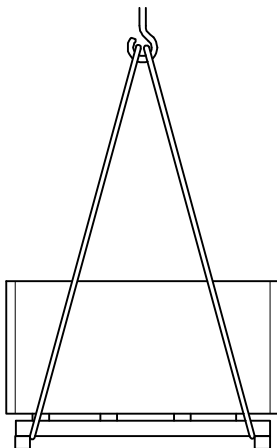

Fig. 7

Packages which are fastened to pallets can be transported by crane under the following conditions:

- The crane and lifting gear must be designed for the weight of the packages.
- The operator must be authorised to operate the crane.

Fastening:

1. Fasten ropes, belts or multiple-point suspension gear to the pallet Fig. 7 accordingly.
2. Check that the packages are not damaged by the fastening equipment. If necessary use other fastening equipment.
3. Begin transportation.

Transporting pallets by forklift

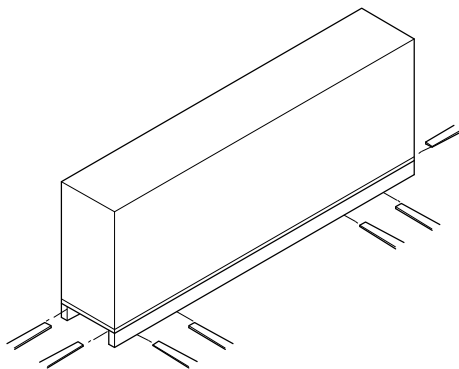

Fig. 8

Packages which are fastened to pallets can be transported by forklift under the following conditions:

- The forklift must be designed for the weight of the units for transportation.
- The driver must be authorised to drive the forklift.

Fastening:

1. Drive the forklift with the forks between or underneath the beams of the pallet.
2. Insert the forks so that they protrude on the opposite side.
3. Make sure that the pallet cannot tilt in case it has an off-centre centre of gravity.
4. Raise the package and begin transportation.

5.3 Packaging

Information on packaging

The individual packages are packaged appropriately for the expected transportation conditions. Only environmentally friendly materials have been used for packaging.

The packaging is designed to protect the individual parts from transport damage, corrosion and other damage up until they are installed. You must therefore not destroy the packaging and not remove it until shortly before installation.

Handling packaging materials

Dispose of packaging material in accordance with the respective valid laws and local regulations.

**CAUTION!**

Risk of environmental damage due to incorrect disposal.

Packaging materials are valuable raw materials and can be re-used in many cases or treated and recycled.

Therefore:

- Dispose of packaging material in an environmentally friendly manner.
- Adhere to the valid local regulations for disposal. Contract a specialist company to carry out disposal as necessary.

5.4 Bearings

Storing packages

Store the packages under the following conditions:

- Do not store in the open.
- Keep in a dry and dust-free environment.
- Do not expose to any corrosive media.
- Protect from sunlight.
- Make sure to store in a low-vibration environment ($v_{\text{eff}} \leq 0.2$ mm/s).
- Avoid large fluctuations in storage temperature.
- Relative air humidity: max. 60 %.
- Check the insulation resistance as necessary (⇒ chapter "Checking the insulation resistance").
- Grease or replace the rolling bearings as necessary (⇒ chapter "Maintenance").
- When storing for longer than 3 months, regularly check the general condition of all parts and the packaging. If necessary, replenish or replace the conservation.



NOTE!

In some cases there will be instructions for storage on the packages informing you of further requirements going beyond those listed here. Adhere to these instructions accordingly.

6 Installation and commissioning

6.1 Safety

Staff

- Installation and commissioning must only be performed by specialist staff with the appropriate qualifications.
- Work on the electrical equipment must only be carried out by qualified electricians.

Personal safety equipment and clothing

Wear the following safety equipment and clothing for all installation and commissioning work:

- Occupational safety clothing
- Safety shoes

Electrical equipment



DANGER!
Danger to life from electrical current.

There is a risk of fatal injury from contact with live parts. Electrical components which are switched on can carry out uncontrolled movements and cause serious injuries.

Therefore:

- Before starting work switch off the electrical power supply and secure it to prevent it from being switched back on.

Securing the machine to prevent it from being switched back on



DANGER!
Risk of fatal injury if the machine is switched back on without authorisation.

When performing installation there is a risk that the energy supply will be switched on without authorisation. This puts the life of people in the danger area at risk.

Therefore:

- Before beginning all work shut off all energy supplies and secure them to prevent them from being switched back on.

Installation and commissioning

Improper installation and commissioning



WARNING!

Risk of injuries from improper installation and commissioning.

Improper installation and commissioning can cause serious personal injury and material damage.

Therefore:

- Before starting work make sure there is sufficient space for performing the installation work.
- Handle open, sharp-edged parts with care.
- Keep the installation area clean and tidy. Loose parts and tools stacked on top of each other or parts and tools left lying around are potential sources of accidents.
- Fit parts properly. Adhere to the stipulated tightening torque values for screws.
- Secure parts to prevent them from falling or toppling.

6.2 Installation

6.2.1 Ventilation at the location for use

The ventilation for the motor must not be obstructed.

You must therefore adhere to the following points:



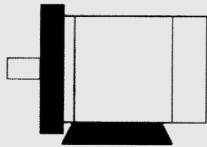
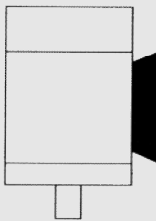
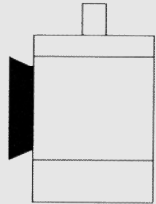
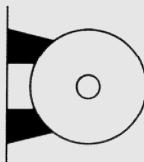
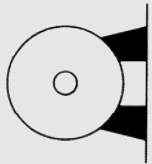
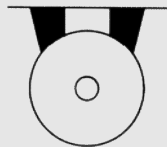

- Make sure that there is sufficient space between the motor fan and the walls and other similar obstructions.
- The clearance to obstructions must be at least $d/4$ (d = diameter of the motor).
- Make sure that the exhaust air is not sucked directly back in.
- In case of heavy soiling clean the air ways regularly.

6.2.2 Types of construction as per EN 60034-7

Type of construction and IM code (international mounting) of the most frequently used versions.

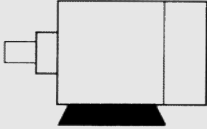
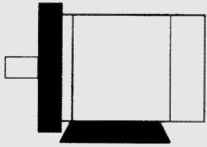
Type of construction	Symbol	Explanation
IM B3 IM 1001		<ul style="list-style-type: none"> ■ 2 bearing shields ■ with feet
IM V5 IM 1011		<ul style="list-style-type: none"> ■ 2 bearing shields ■ with feet ■ Shaft end bottom ■ Fastening on the wall
IM V6 IM 1031		<ul style="list-style-type: none"> ■ 2 bearing shields ■ with feet ■ Shaft end top ■ Fastening on the wall
IM B6 IM 1051		<ul style="list-style-type: none"> ■ 2 bearing shields ■ with feet ■ Construction type IM B3 ■ Fastening on the wall ■ Feet left, viewed from drive side
IM B7 IM 1061		<ul style="list-style-type: none"> ■ 2 bearing shields ■ with feet ■ Construction type IM B3 ■ Fastening on the wall ■ Feet right, viewed from drive side
IM B8 IM 1071		<ul style="list-style-type: none"> ■ 2 bearing shields ■ with feet ■ Construction type IM B3 ■ Fastening on the ceiling

Installation and commissioning

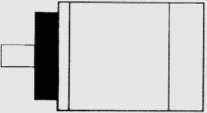
Type of construction	Symbol	Explanation
IM B15 IM 1201		<ul style="list-style-type: none"> ■ 1 bearing shield ■ with feet ■ Construction type IM B3 ■ without bearing shield (also without rolling bearing) on drive side ■ Installation on substructure ■ Attached to front of housing on drive side
IM B35 IM 2001		<ul style="list-style-type: none"> ■ 2 bearing shields ■ with feet ■ Securing flange type A
IM B34 IM 2101		<ul style="list-style-type: none"> ■ 2 bearing shields ■ with feet ■ Securing flange type C
IM B5 IM 3001		<ul style="list-style-type: none"> ■ 2 bearing shields ■ without feet ■ Securing flange type A
IM V1 IM 3011		<ul style="list-style-type: none"> ■ 2 bearing shields ■ without feet ■ Shaft end bottom ■ Securing flange type A
IM V3 IM 3031		<ul style="list-style-type: none"> ■ 2 bearing shields ■ without feet ■ Shaft end top ■ Securing flange type A
IM B14 IM 3601		<ul style="list-style-type: none"> ■ 2 bearing shields ■ without feet ■ Securing flange type C

Installation and commissioning

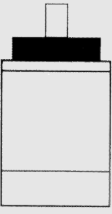
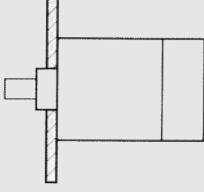
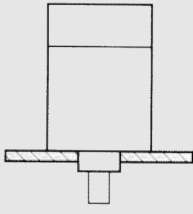
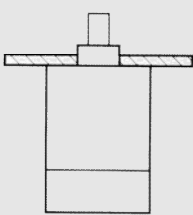
Type of construction	Symbol	Explanation
IM V18 IM 3611		<ul style="list-style-type: none"> ■ 2 bearing shields ■ without feet ■ Shaft end bottom ■ Securing flange type C
IM V19 IM 3631		<ul style="list-style-type: none"> ■ 2 bearing shields ■ without feet ■ Shaft end top ■ Securing flange type C
IM B9 IM 9101		<ul style="list-style-type: none"> ■ 1 bearing shield ■ without feet ■ Construction type IM B5 or IM B14 ■ without bearing shield (also without rolling bearing) on drive side ■ Attached to front of housing on drive side
IM V8 IM 9111		<ul style="list-style-type: none"> ■ 1 bearing shield ■ without feet ■ Shaft end bottom ■ Construction type IM V1 or IM V18 ■ without bearing shield (also without rolling bearing) on drive side ■ Attached to front of housing on drive side
IM V9 IM 9131		<ul style="list-style-type: none"> ■ 1 bearing shield ■ without feet ■ Shaft end top ■ Construction type IM V3 or IM V19 ■ without bearing shield (also without rolling bearing) on drive side ■ Attached to front of housing on drive side

Installation and commissioning

6.2.3 Erecting the machine

**DANGER!****Risk of death due to insufficient protection classes.**

Insufficient protection classes can lead to considerable material damage, serious personal injury or even death.

Therefore:

- Do not erect machine of protection class \leq IP23 in the open.

In order to ensure that the machine runs quietly and with low vibrations make sure of the following when erecting the machine:

- the foundation must be stable
- the foundation's natural frequency with the machine must be sufficiently different to the rotary frequency and the double mains frequency
- the motors must be aligned accurately
- the drive machines must be well balanced

6.2.4 Installation

Installation varies depending on the construction type. In case you have any doubts contact the service department (\Rightarrow page 2).

When installing, always pay attention to the following points:

- All connection elements (walls, ceilings etc .) must be of sufficient size.
- The rotor is dynamically balanced with a half feather key. Take this into account when balancing the drive element.
- Avoid incorrect belt tension (\Rightarrow catalogue). Cover couplings and belt pulleys with a guard to protect accidental contact.
- Fit and remove drive elements (couplings, belt pulley, toothed wheels etc.) with the suitable devices.
- Tighten all screw connections with the appropriate tightening torque (\Rightarrow chapter "Tightening torque values for screws").
- Fit construction types with the shaft ends at the bottom with a cover to prevent foreign bodies from falling into the motor's fan.
- Any condensation drain holes must be positioned at the lowest point of the motor when installed and cleaned of any impurities.
- Take generally required measures for preventing accidental contacts between drive elements

6.3 Connecting to the energy supply

Electrical current



DANGER!

Danger to life from electrical current.

There is an immediate risk of fatal injury in case of contact with live parts. Damage to the insulation or individual components can mean danger to life.

Therefore:

- In case of damage to the insulation, switch off the power supply immediately and have repairs carried out.
- Have work on the electrical equipment carried out by qualified electricians only.
- When any work is carried out on the electrical equipment, disconnect it from the power and make sure it is free of voltage.
- Before carrying out maintenance, cleaning and repair work, switch off the power supply and secure it to prevent it from being switched back on.
- Do not jumper or disable any fuses or circuit breakers. When replacing fuses or circuit breakers make sure to adhere to the correct ampere rating.
- Keep moisture away from live parts. It can lead to a short circuit.

6.3.1 Voltage, frequency and circuit

- Adhere to the wiring specification on the type plate and wiring diagram in the terminal box.
- Compare the operating voltages and supply voltages.
- Motor rated voltages and the supply voltage must not differ $\pm 5\%$; $\pm 2\%$ is permitted for the rated frequency.

Installation and commissioning

6.3.2 Checking the insulation resistance

- To be performed by a qualified electrician only



DANGER!
Risk of death due to uncontrolled fault currents.

Insulation faults can call potentially fatal fault currents.

Therefore:

- The value of the insulation resistance must be higher than the critical value of 0.5 MΩ.
- In case the value drops below the critical insulation resistance, take the motor out of operation and shut it down immediately.



DANGER!
Danger to life from electrical current.

When measuring and immediately afterwards the terminals carry partly dangerous voltages.

Therefore:

- Do not touch the terminals.
- Discharge after measuring.

Before commissioning the motor, after a longer period of storage or without use, the insulation resistance of the coils has to be determined again. When doing so, adhere to the valid standards and directives.

6.4 Commissioning



DANGER!
Danger to life from electrical current.

There is an immediate risk of fatal injury in case of contact with live parts.

Therefore:

- Only carry out work with the plant free of voltage.
- Secure the plant to prevent it from being switched back on.

**CAUTION!**

Risk of personal injury and/or material damage from feather keys ejected at speed.

When commissioning a motor without drive elements the feather keys may be ejected at speed.

Therefore:

- Before commissioning motors without drive elements remove or secure the feather keys beforehand.

Before commissioning make sure that:

- the minimum insulation resistance values are adhered to (⇒ chapter "Checking the insulation resistance").
- the rotor can be turned without starting up.
- the motor is properly fitted and aligned.
- any condensation drain holes are open.
- the drive elements have the right settings (e.g. belt tension for belt drive etc.)
- the drives are suitable for the conditions of use.
- all electrical connections, fastening screws and fastening elements are the right type and are tightened properly.
- the protective earth conductor connection is properly established.
- measures to prevent accidental contacts for mowing and live parts have been taken.

**NOTE!**

Commissioning is performed using the overall plant control unit (⇒ Operating manual for the complete plant).

7 Operations

7.1 General information

During operation no staff are required in the machine area or in the direct vicinity to operate it.

Operation is performed using the overall plant control unit
(⇒ Operating manual for the complete plant).

7.2 Shutting down in an emergency

In danger situations machine movements must be stopped as quickly as possible and the energy supply has to be switched off.

Shutting down in an emergency

In case of danger proceed as follows:

1. Trigger an emergency stop immediately.
2. Remove any people from the danger zone and administer first aid.
3. Alert a doctor and the fire services.
4. Inform the responsible party at the location.
5. Switch off the master switch and secure it to prevent it from being switched back on.
6. Keep access routes for emergency vehicles clear.
7. If the seriousness of the emergency requires it, inform the respective authorities.
8. Have specialist staff remedy the fault.

After emergency measures



WARNING!

Risk of death from switching on prematurely.

When switching back on there is a risk of fatal injury for all people in the danger area.

Therefore:

- Before switching back on make sure that there is nobody in the danger area.

9. Before re-starting check the plant and make sure that all safety devices are installed and fully functional.

8 Faults

The following chapter describes possible causes of faults and the work to eradicate them.

In case of faults which occur several times, reduce the maintenance interval accordingly to suit the actual strain.

In case of faults which cannot be cleared using the following instructions, contact the manufacturer, see service address on page 2.

8.1 Safety

Staff

- Some tasks can only be carried out by specialist staff with special qualifications or exclusively by the manufacturer. The description of the respective individual fault makes reference to this in each case.
- Work on the electrical equipment must only be carried out by qualified electricians.

Personal safety equipment and clothing

Wear the following safety equipment and clothing for all faults work:

- Occupational safety clothing
- Safety shoes

Electrical equipment



DANGER!

Danger to life from electrical current.

There is a risk of fatal injury from contact with live parts. Electrical components which are switched on can carry out uncontrolled movements and cause serious injuries.

Therefore:

- Before starting work switch off the electrical power supply and secure it to prevent it from being switched back on.

Faults

Securing the machine to prevent it from being switched back on



DANGER!

Risk of death from switching on without authorisation.

When working to remedy faults there is a risk that the energy supply will be switched on without authorisation. This puts the life of people in the danger area at risk.

Therefore:

- Before beginning all work shut off all energy supplies and secure them to prevent them from being switched back on.

Improper eradication of faults



WARNING!

Risk of injuries from incorrectly eradicating faults.

Eradicating faults incorrectly can cause serious personal injury and material damage.

Therefore:

- Before starting work make sure there is sufficient space for performing the installation work.
- Keep the installation area clean and tidy. Loose parts and tools stacked on top of each other or parts and tools left lying around are potential sources of accidents.
- If parts have been removed, make sure they are installed properly, re-install all fastening elements and adhere to the tightening torque values for screws.

How to act in case of faults

The following basic instructions apply:

1. In case of faults which pose an immediate risk to people or objects of material value, activate the emergency stop function immediately.
2. Determine the cause of the fault.
3. If eradicating the fault requires work in the danger area, switch off the plant and secure it to prevent it from being switched back on.
4. Inform the responsible party at the location of the fault immediately.
5. Depending on the type of fault, have it remedied by specialist staff or remedy it yourself.



NOTE!

The following fault table provides information on who is authorised to remedy the fault.

8.2 Fault table

Fault	Possible cause	Remedy	To be remedied by
<ul style="list-style-type: none"> ■ Bearing is too worn 	Too much grease in the bearing	Remove excessive grease	Qualified specialist
	Bearing is soiled	Replace the bearing	Manufacturer
	Belt tension too high	Reduce belt tension	Qualified specialist
	Bearing grease dark in colour	Check for bearing currents	Qualified specialist
<ul style="list-style-type: none"> ■ Bearing is too worn ■ Motor is not running smoothly 	Coupling forces are pulling or pushing	Align the motor exactly, adjust the coupling	Qualified specialist
<ul style="list-style-type: none"> ■ Bearing is too worn ■ Bearing noises 	Not enough grease in the bearing	Lubricate as stipulated	Qualified specialist
<ul style="list-style-type: none"> ■ Bearing is too worn ■ Bearing noises ■ Motor is not running smoothly 	Motor erected incorrectly	Check the motor construction type	Qualified specialist
<ul style="list-style-type: none"> ■ Bearing noises 	Scoring on inner bearing ring, e.g. from motor starting up with bearing locked	Replace bearing, avoid vibrations when at a standstill	Manufacturer
<ul style="list-style-type: none"> ■ Motor is not running smoothly 	Imbalance due to belt pulley or coupling	Balance exactly	Manufacturer
	Machine fastening insufficient	Check machine fastening	Qualified specialist
<ul style="list-style-type: none"> ■ Motor does not start up ■ Considerable drop in speed 	Load moment too high	Check motor torque and load moment	Qualified electrician
	Supply voltage too low	Check power supply conditions	Qualified electrician
<ul style="list-style-type: none"> ■ Motor does not start up ■ Considerable drop in speed ■ Safety device is triggered 	Phase unbalance	Check the mains connection	Qualified electrician

Faults

Fault	Possible cause	Remedy	To be remedied by
<ul style="list-style-type: none"> ■ Motor does not start up ■ Motor is too warm ■ Considerable drop in speed ■ Safety device is triggered 	Incorrect circuit	Adhere to wiring diagram and type plate	Qualified electrician
<ul style="list-style-type: none"> ■ Motor is too warm ■ Considerable drop in speed ■ Safety device is triggered 	Overload	Adhere to stipulations on type plate	Qualified electrician
<ul style="list-style-type: none"> ■ Motor is too warm ■ Safety device is triggered 	Too many switching actuations	Observe rated operating mode	Qualified electrician
<ul style="list-style-type: none"> ■ Motor is too warm 	Ventilation insufficient	Check the cooling air ducts, check the direction of rotation	Qualified electrician
	Ventilation ducts soiled	Clean the ventilation ducts	Qualified specialist
<ul style="list-style-type: none"> ■ Safety device is triggered 	Coil or terminal short circuit	Measure the insulation resistance	Qualified electrician
	The start-up time has been exceeded	Check the start-up conditions	Qualified electrician

8.3 Commissioning after remedied fault

After remedying the fault carry out the following steps for re-commissioning:

1. Reset the emergency stop devices.
2. Acknowledge the fault on the control unit.
3. Make sure that there is nobody in the danger area.
4. Start by following the instructions in the chapter "Operation".

9 Maintenance

9.1 Safety

Staff

- The maintenance work described here can be carried out by the operator unless otherwise stated.
- Some maintenance tasks can only be carried out by specialist staff with special qualifications or exclusively by the manufacturer. The description of the respective individual maintenance task makes reference to this in each case.
- Work on the electrical equipment must only be carried out by qualified electricians.

Personal safety equipment and clothing

Wear the following safety equipment and clothing for all maintenance work:

- Occupational safety clothing
- Safety shoes

Electrical equipment



DANGER!

Danger to life from electrical current.

There is a risk of fatal injury from contact with live parts. Electrical components which are switched on can carry out uncontrolled movements and cause serious injuries.

Therefore:

- Before starting work switch off the electrical power supply and secure it to prevent it from being switched back on.

Maintenance

Improperly performed maintenance work



WARNING!

Risk of injury due to improperly performed maintenance work.

Performing maintenance incorrectly can cause serious personal injury and material damage.

Therefore:

- Before starting work make sure there is sufficient space for performing the installation work.
- Keep the installation area clean and tidy. Loose parts and tools stacked on top of each other or parts and tools left lying around are potential sources of accidents.
- If parts have been removed, make sure they are installed properly, re-install all fastening elements and adhere to the tightening torque values for screws.

Securing the machine to prevent it from being switched back on



DANGER!

Risk of death from switching on without authorisation.

When performing maintenance there is a risk that the energy supply will be switched on without authorisation. This puts the life of people in the danger area at risk.

Therefore:

- Before beginning all work shut off all energy supplies and secure them to prevent them from being switched back on.

Environmental protection

Adhere to the following instructions on environmental protection when performing maintenance work:

- At all lubricating points which are supplied with lubricant by hand, remove the expelled, used or excess grease and dispose of it in accordance with the local regulations.
- Collect replaced oil in suitable containers and dispose of it in accordance with the local regulations.

9.2 Cleaning

- Do not spray electrical machines with water or other liquids.
- Check the entire route for cooling air for soiling at least once a year.

9.3 Maintenance schedule

The next sections describe maintenance work which is required to ensure optimum and fault-free operation.

If during regular checks increased wear is identified, shorten the required maintenance intervals to match the actual signs of wear.

In case you have any questions on maintenance work and intervals, contact the manufacturer, see service address on page 2.

The standard version motors are fitted with permanently lubricated bearings.

Motors from construction type 160 and above can be fitted with lubricating equipment. The lubricating intervals depend on many influence factors. The following table applies under normal operating conditions.



NOTE!

In case of questions on lubrication, contact the manufacturer.

See page 2 for contact details.

Lubricating the ball bearings - intervals in operating hours

Construction size	Quantity of grease [g]	Speed [min^{-1}]					
		3600	3000	1800	1500	1000	500
160	25	7000	9500	14000	17000	21000	24000
180	30	6000	8000	13500	16000	20000	23000
200	40	4000	6000	11000	13000	17000	21000
225	50	3000	5000	10000	12500	16500	20000

9.4 Tightening torque values for screws



NOTE!

Replaced screws which can no longer be used with new screws of the same type and property class.

If not otherwise stated, the following tightening torque values apply for screw connections.

9.4.1 Tightening torque values for screws for electrical connections

Thread	Tightening torque value [Nm]	Thread	Tightening torque value [Nm]
M 4	1,2	M 12	15,5
M 5	2	M 16	30
M 6	3	M 20	52
M 8	6	M 24	80
M 10	10	M 30	150

9.4.2 Screw connections, property class 8.8 and A4-70



NOTE!

Only use tightening torque values for screws of property class 8.8 and A4-70 (A4-80) in high-strength parts (e.g. grey cast iron, steel).

Thread	Tightening torque value [Nm]	Thread	Tightening torque value [Nm]
M 4	2,3	M 14	105
M 5	4,6	M 16	160
M 6	7,9	M 20	330
M 8	19	M 24	560
M 10	38	M 30	1100
M 12	66	M 36	1900

9.4.3 Screw connections of property class 5.6

NOTE!

Only use tightening torque values for screws of property class 5.6, 4.6 A2 or for screws in low-strength parts (e.g. aluminium).

Thread	Tightening torque value [Nm]	Thread	Tightening torque value [Nm]
M 4	1,1	M 14	49
M 5	2,1	M 16	75
M 6	3,7	M 20	150
M 8	8,9	M 24	260
M 10	18	M 30	520
M 12	30	M 36	920

9.5 Measures on completion of maintenance

On completion of maintenance work, carry out the following steps before switching on:

1. Check that all screw connections which have been unfastened are fastened securely again.
2. Check whether all the safety devices and covers which have been removed have been properly re-installed.
3. Make sure that all tools, materials and other equipment which have been used, have been removed from the working area.
4. Clean the working area and remove any substances, e.g. liquids, processing material etc.
5. Make sure that all the plant's safety devices are in perfect working order.

10 Removal

Once the period of use has expired, the machine must be removed and disposed of in an environmentally friendly manner.

10.1 Safety

Staff

- The machine must only be removed by qualified specialist staff with the appropriate qualifications.
- Work on the electrical equipment must only be carried out by qualified electricians.

Electrical equipment



DANGER!

Danger to life from electrical current.

There is a risk of fatal injury from contact with live parts. Electrical components which are switched on can carry out uncontrolled movements and cause serious injuries.

Therefore:

- Before starting removal work switch off the electrical supply and disconnect it permanently.

Improper removal



WARNING!

Risk of injury from improper removal.

Stored residual energy, sharp parts, points and corners on and in the device or on the required tools can cause injuries.

Therefore:

- Before starting work make sure there is sufficient space.
- Handle open, sharp-edged parts with care.
- Keep the working area clean and tidy. Loose parts and tools stacked on top of each other or parts and tools left lying around are potential sources of accidents.
- Remove parts properly. Be aware that some parts have a heavy dead weight. Use lifting gear as necessary.
- Secure parts to prevent them from falling or toppling.
- In case of doubt, contact the manufacturer.

10.2 Removal

Before starting removal:

- Switch off the machine and secure it to prevent it from being switched back on.
- Physically disconnect the entire energy supply and discharge stored residual energy.
- Remove fuels and consumables and residual processing materials and dispose of them in an environmentally friendly manner.

Then clean assembly groups and parts properly and dismantle then in accordance with the local regulations for occupational safety and environmental protection.



Removal

10.3 Disposal

If no agreements have been made for return or disposal, have the dismantled components recycled:

- Have metals scrapped.
- Hand over plastic elements for recycling.
- Sort and dispose of other components according to the material properties.

**CAUTION!**

Risk of environmental damage due to incorrect disposal.

Electrical scrap, electronic components, lubricants and consumables require special waste treatment and must only be disposed of by approved specialist companies.

The local authorities or specialist disposal companies can provide information on environmentally friendly disposal.

11 Index

A

Accident..... 17

B

Bearings..... 22, 26

C

Cleaning..... 43

Commissioning 34

Connecting..... 33

Connections..... 21

Construction..... 20

Contacts..... 8

Copyright 8

Customer service 8

D

Danger zone 17

Delivery inspection 23

Disposal 48

E

Electrical current 14, 33

Emergency stop 36

Environmental protection..... 18

F

Fastening eyebolts 24

Fault table..... 39

Faults..... 37

Fire 17

First aid..... 17

H

Hazards 13

I

Improper use..... 12

Installation..... 28

L

Liability..... 7

Lubricants 18

M

Maintenance

Maintenance schedule 43

O

Operating conditions 19

Operations 36

Overview..... 20

P

Packaging 22, 25

Proper use 12

Q

Qualified electrician 10

R

Removal..... 46, 47

S

Safety

general information 9

Safety devices..... 16

Safety equipment and clothing..... 13

Faults 37

Installation 27

Maintenance..... 41

Safety shoes..... 13

Securing the machine to prevent it from being
switched back on 16

Service..... 8

Spare parts 8

Specialist staff 10

Staff

Commissioning 27

Faults 37

Installation 27

Maintenance..... 41

Removal 46

Requirements 10

**Index**

Surfaces, hot.....	15	Crane	24
Symbols		Fork lift	24
in the manual.....	6	Type plate.....	19
T		U	
Technical data	19	Use	12
Tightening torque values for screws	44	User.....	9
Training	10	W	
Transportation.....	22, 23	Warranty.....	8